

SG NEW

MANTUA MODEL
GROUP

SPACE EUROPA 4WD

La "SPACE EUROPA" è un prodotto tutto italiano realizzato dal più grande produttore di Automodelli 1/8 del Mondo; significa avere il massimo del momento e la immediata disponibilità dei pezzi di ricambio. Il gran numero di Automodelli SG presenti in tutto il mondo significa fiducia assoluta nella competenza e serietà della SG. Il titolo di Campione Europeo 1988 è giunto quindi a conferma delle doti competitive del mezzo. Il prezzo incredibilmente basso, frutto di una tecnologia produttiva d'avanguardia, rende questo modello sofisticato accessibile a tutti.

"SPACE EUROPA" is an Italian unit carried out by the greatest manufacturer over the world of 1/8 car models; this means the best of the moment and the immediate availability of spare parts. The high number of SG car models over the world means absolute trust in the competence and seriousness of SG. The title of European Champion 1988 is the confirmation of the racing value of the car. The low price, result of an advanced technology, offers to everybody the chance to race with this sophisticated model.

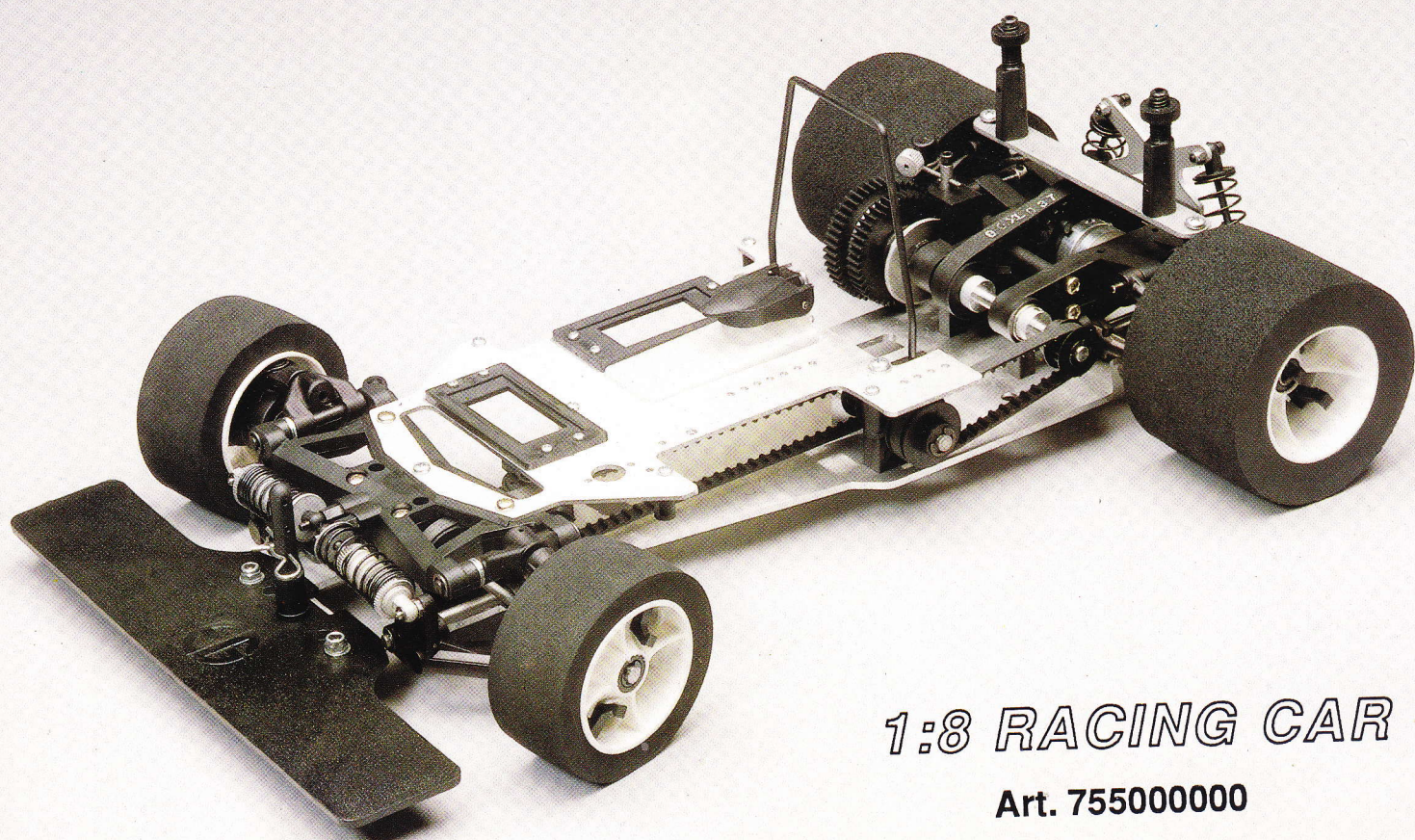

1:8 RACING CAR

Art. 755000000

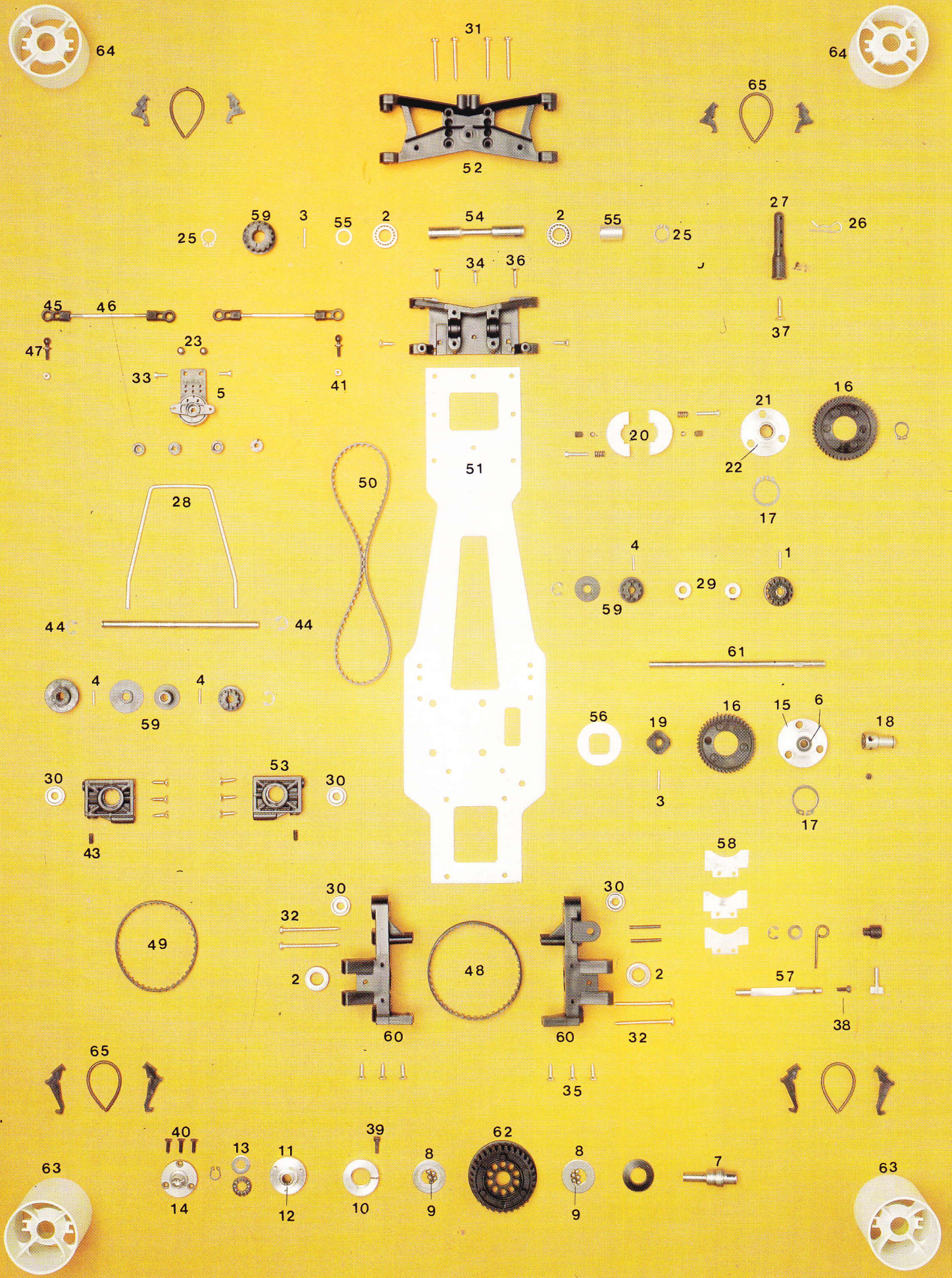

RICAMBI

N.	Articolo	Descrizione	N.	Ident N.	Description
1	700020244	Rullino mm. 2x13,8	1	700020244	Pin - 2x13,8 mm
2	700020435	Cuscinetto mm. 10x19x5	2	700020435	Ball-bearing - 10x19x5 mm
3	700022616	Rullino mm. 2x15,8	3	700022616	Pin - 2x15,8 mm
4	700022710	Rullino mm. 2x11,8	4	700022710	Pin - 2x11,8 mm
5	700022758	Salvaservo completo	5	700022758	Servo-saver
6	700022906	Cuscinetto mm. 6x13x5	6	700022906	Ball-bearing - 6x13x5 mm
7	700022909	Semiasse porta corona destro	7	700022909	Right axle - gear side
8	700022911	Ralla mm. 12x26x1	8	700022911	Washer - 12x26x1 mm
9	700022913	Sfera mm. 4	9	700022913	Ball mm. 4
10	700022914	Ghiera di pressione	10	700022914	Trimming collar
11	700022915	Supporto semiasse sinistro	11	700022915	Left axle support
12	700022916	Cuscinetto a rullini mm. 7x11x9	12	700022916	Needle-bearing - 7x11x9 mm
13	700022917	Cuscinetto reggisplinta mm. 7x15	13	700022917	Ball-bearing - 7x15 mm
14	700022918	Semiasse sinistro	14	700022918	Left axle
15	700022931	Trascinatore corona II marcia	15	700022931	Second gear holder
16	700022932	Corone Z 44 - Z 48	16	700022932	Crown gears - Z 44 - Z 48
17	700022933	Benzing per albero mm. 19	17	700022933	Circlip - 19 mm
18	700022935	Trascinatore I e II marcia	18	700022935	High speed holder
19	700022936	Trascinatore disco freno	19	700022936	Disk brake holder
20	700022941	Gruppo frizione cambio	20	700022941	Gear box shoes
21	700022942	Trascinatore corona I marcia	21	700022942	First gear holder
22	700022943	Cuscinetto unidirezionale mm. 10	22	700022943	One way pin bearing - 10 mm
23	700022967	Sfera per uniball mm. 6	23	700022967	Ball for uniball - 6 mm
24	700022979	Benzing per albero mm. 6	24	700022979	Circlip - 6 mm
25	700023102	Benzing per albero mm. 10	25	700023102	Circlip - 10 mm
26	708100000	Clips	26	708100000	Clips
27	745003701	Colonna anteriore	27	745003701	Front pillar
28	745752200	Roll-bar	28	745752200	Roll-bar
29	745801600	Collare mm. 6x13x6	29	745801600	Collar - 6x13x6 mm
30	700022906	Cuscinetto mm. 6x13x5	30	700022906	Ball-bearing - 6x13x5 mm
31	748005000	Vite autofilettante mm. 3,5x32	31	748005000	Self tapping screw - 3,5x32 mm
32	748005300	Vite autofilettante mm. 3,5x45	32	748005300	Self tapping screw - 3,5x45 mm
33	748012200	Vite TC MA 3x8 mm.	33	748012200	Screw 3x8 MA
34	748020400	Vite autofilettante TS mm. 3,5x9,5	34	748020400	Self tapping screw - 3,5x9,5 mm
35	748020500	Vite autofilettante TS mm. 3,5x13	35	748020500	Self tapping screw - 3,5x13 mm
36	748021000	Vite autofilettante TS mm. 3,5x16	36	748021000	Self tapping screw - 3,5x16 mm
37	748022000	Vite autofilettante TS mm. 4,2x19,5	37	748022000	Self tapping screw - 4,2x19,5 mm
38	748030100	Vite TC brugola MA 3x8 mm.	38	748030100	Screw - 3x8 MA
39	748030500	Vite TC brugola MA 3x10 mm.	39	748030500	Screw - 3x10 MA
40	748040500	Vite TS MA 3x10 mm.	40	748040500	Screw - 3x10 MA
41	748064000	Dado autobloccante 3 MA	41	748064000	Stop-nut - 3 MA
42	748070500	Grano MA 4x4 mm.	42	748070500	Screw - 4x4 MA
43	748071500	Grano MA 4x8 mm.	43	748071500	Screw - 4x8 MA
44	748091000	Seger per albero mm. 6	44	748091000	Circlip - 6 mm
45	749505100	Uniball mm. 6	45	749505100	Uniball - 6 mm
46	749505200	Tirante sterzo mm. 3x60	46	749505200	Steering rod - 3x60 mm
47	751120400	Sfera uniball mm. 6	47	751120400	Ball for uniball - 6 mm
48	754007300	Cinghia 90 - 037 XL	48	754007300	Belt 90 - 037 XL
49	754007400	Cinghia 80 - 025 XL	49	754007400	Belt 80 - 025 XL
50	754007500	Cinghia 170 - 025 XL	50	754007500	Belt 170 - 025 XL
51	755000100	Planale	51	755000100	Chassis
52	755000300	Avantreno inferiore - superiore	52	755000300	Low - upper front axle
53	755000400	Supporto assale centrale	53	755000400	Central axle support
54	755000500	Asse anteriore mm. 10x74	54	755000500	Front axle - 10x74 mm
55	755000600	Distanziali assale anteriore	55	755000600	Front axle spacers
56	755001200	Disco del freno	56	755001200	Disk brake
57	755001300	Gruppo camme freno	57	755001300	Brake axle set
58	755001400	Piastrine freno	58	755001400	Brake plate
59	755001500	Serie pulegge	59	755001500	Pulley set
60	755003000	Supporto differenziale dx - sx	60	755003000	Differential support - right & left
61	755010100	Albero cambio mm. 6x132	61	755010100	Gear box axle - 6x132 mm
62	755050100	Puleggia differenziale Z 32	62	755050100	Differential pulley - 32 T.
63	756002300	Cerchio posteriore	63	756002300	Rear hub
64	756002400	Cerchio anteriore	64	756002400	Front hub
65	756002800	Sgancio rapido	65	756002800	Quick change

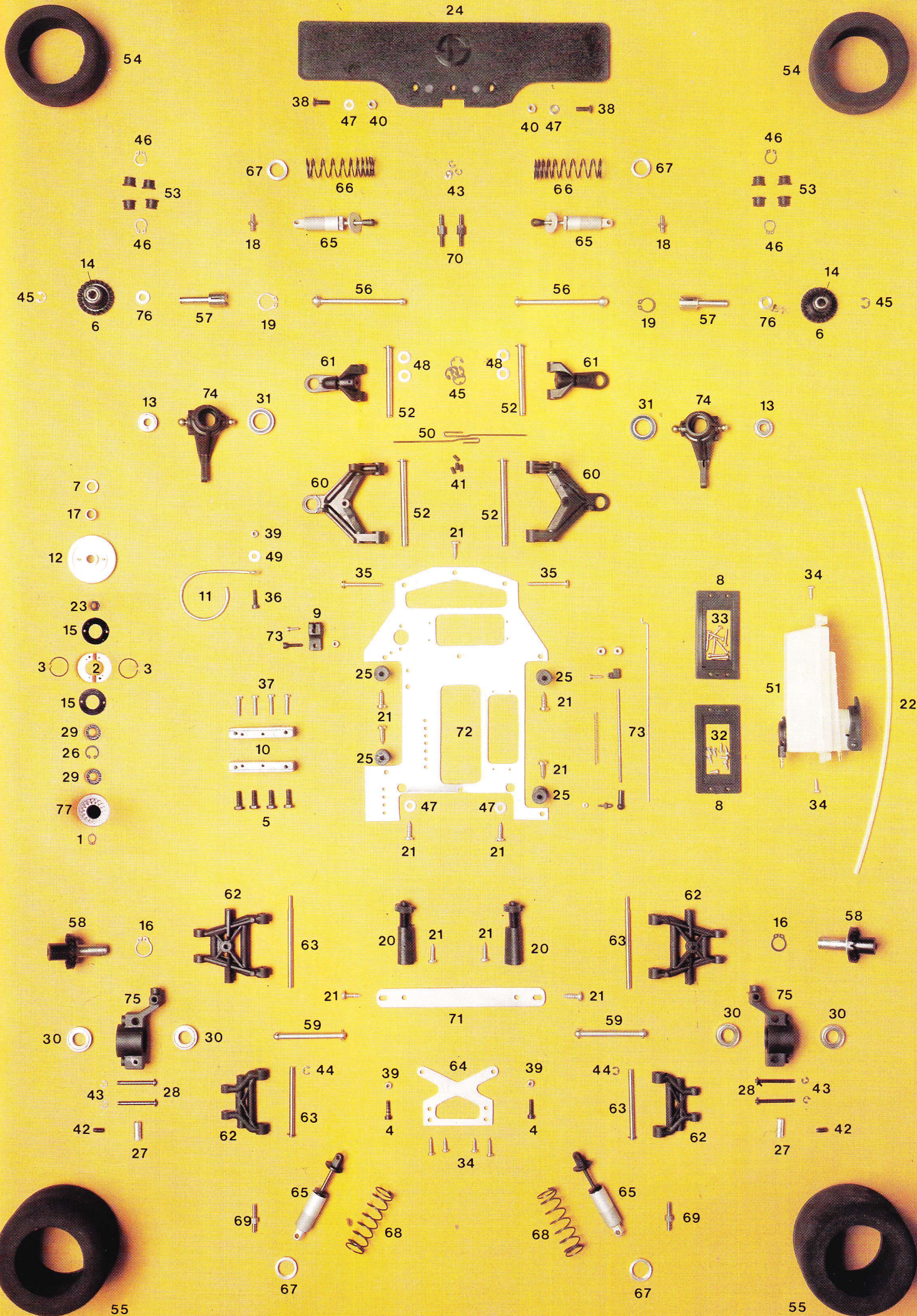

SPARE PARTS

N.	Articolo	Descrizione	N.	Ident N.	Description
1	700020221	Benzing per albero mm. 5	1	700020221	Circlip - 5 mm
2	700020290	Ceppo frizione	2	700020290	Clutch shoe
3	700020291	Molla frizione	3	700020291	Clutch spring
4	700020508	Vite TC MA 3x12 mm.	4	700020508	Screw - 3x12 MA
5	700020513	Vite TE MA 4x12 mm	5	700020513	Screw - 4x12 MA
6	700021206	Trascinatore ruota anteriore	6	700021206	Front hub holder
7	700022357	Distanziale mm. 7x12x1,5	7	700022357	Spacer - 7x12x1,5 mm
8	700022439	Piastrina porta servo	8	700022439	Servo mount
9	700022440	Blocco porta antenna	9	700022440	Antenna socket
10	700022462	Castello motore	10	700022462	Engine - mount
11	700022641	Supporto marmitta	11	700022641	Exhaust support
12	700022846	Volano motore	12	700022846	Fly-wheel
13	700022906	Cuscinetto mm. 6x13x5	13	700022906	Ball-bearing - 6x13x5 mm
14	700022982	Cuscinetto unidirezionale mm. 6	14	700022982	One way pin bearing - 6 mm
15	700020302	Distanziale mm. 12x23x0,2	15	700020302	Spacer - 12x23x0,2 mm
16	700023102	Benzing per albero mm. 10	16	700023102	Circlip - 10 mm
17	700570660	Cono volano	17	700570660	Fly-wheel cone
18	703301044	Perno supporto ammortizzatore mm. 15	18	703301044	Shock absorber pin - 15 mm
19	700022659	Benzing per albero mm. 12	19	700022659	Circlip - 12 mm
20	703301083	Colonna posteriore	20	703301083	Rear pillar
21	703301089	Vite autofilettante mm. 3,9x13	21	703301089	Self tapping screw - 3,9x13 mm
---	703662000	Olio ammortizzatore	---	703662000	Shock absorber oil
22	708130000	Tube antenna	22	708130000	Antenna tubing
23	737007100	Dado motore	23	737007100	Engine nut
24	745003900	Paraurti anteriore	24	745003900	Front bumper
25	745009200	Colonna porta ricevente	25	745009200	Power pack pillar
26	745150000	Molla per cuscinetto	26	745150000	Spring for ball-bearing
27	745751401	Eccentrico regolazione Camber	27	745751401	Camber tuning cam
28	745757200	Perno mozzo posteriore mm. 3x30	28	745757200	Rear pin - 3x30 mm
29	747000400	Cuscinetto mm. 5x13x4	29	747000400	Ball-bearing - 5x13x4 mm
30	747002100	Cuscinetto mm. 10x19x5	30	747002100	Ball-bearing - 10x19x5 mm
31	747002300	Cuscinetto mm. 12x21x5	31	747002300	Ball-bearing - 12x21x5 mm
32	748000100	Vite autofilettante mm. 2,2x6,5	32	748000100	Self tapping screw - 2,2x6,5 mm
33	748001000	Vite autofilettante mm. 2,2x13	33	748001000	Self tapping screw - 2,2x13 mm
34	748003000	Vite autofilettante mm. 2,9x9,5	34	748003000	Self tapping screw - 2,9x9,5 mm
35	748005000	Vite autofilettante mm. 3,5x32	35	748005000	Self tapping screw - 3,5x32 mm
36	748012500	Vite TC MA 3x10 mm.	36	748012500	Screw - 3x10 MA
37	748013000	Vite TC MA 3x12 mm.	37	748013000	Screw - 3x12 MA
38	748042500	Vite TS MA 4x12 mm.	38	748042500	Screw - 4x12 MA
39	748064000	Dado autobloccante 3 MA	39	748064000	Stop-nut - 3 MA
40	748064500	Dado autobloccante 4 MA	40	748064500	Stop-nut - 4 MA
41	748070100	Grano MA 3x6 mm.	41	748070100	Screw - 3x6 MA
42	748071500	Grano MA 4x8 mm.	42	748071500	Screw - 4x8 MA
43	748090100	Seger per albero mm. 3	43	748090100	Circlip - 3 mm
44	748090200	Seger per albero mm. 4	44	748090200	Circlip - 4 mm
45	748090500	Seger per albero mm. 5	45	748090500	Circlip - 5 mm
46	748093700	Benzing per albero mm. 8	46	748093700	Circlip - 8 mm
47	748100100	Rondella mm. 4	47	748100100	Washer - 4 mm
48	748101100	Rondella mm. 5	48	748101100	Washer - 5 mm
49	748101500	Rondella mm. 3	49	748101500	Washer - 3 mm
50	751005600	Barra anteriore	50	751005600	Front stabilizer
51	751010000	Serbatoio completo	51	751010000	Tank
52	754000800	Perni sospensione anteriore	52	754000800	Front suspension pin
53	754003200	Boccola sferica	53	754003200	Ball housing
54	754009500	Gomme anteriori	54	754009500	Front tyres
55	754009600	Gomme posteriori	55	754009600	Rear tyres
56	755000700	Cardano anteriore	56	755000700	Front swivel
57	755000701	Asse ruota	57	755000701	Hub axle
58	755001000	Trascinamento cerchio posteriore	58	755001000	Rear hub holder
59	755001100	Cardano posteriore	59	755001100	Rear swivel
60	755001600	Bracci anteriori inferiori	60	755001600	Front lower arm
61	755001700	Bracci anteriori superiori	61	755001700	Front upper arm
62	755001800	Bracci posteriori	62	755001800	Rear arm
63	755001900	Perni sospensioni posteriori	63	755001900	Rear suspension pin
64	755002000	Supporto ammortizzatore posteriore	64	755002000	Shock absorber support
65	755002010	Ammortizzatore completo	65	755002010	Shock absorber
66	755002020	Molla ammortizzatore anteriore	66	755002020	Front shock absorber spring
67	755002030	Ghiera di registro	67	755002030	Tuning nut
68	755002050	Molla ammortizzatore posteriore	68	755002050	Rear shock absorber spring
69	755002100	Perno supporto ammortizzatore mm. 21,5	69	755002100	Shock absorber pin support - 21,5 mm
70	755002110	Perno supporto ammortizzatore mm. 24,5	70	755002110	Shock absorber pin support - 24,5 mm
71	755002200	Piastra supporto carrozzeria	71	755002200	Body plate support
72	755002300	Piastra radio	72	755002300	Radio plate
73	755002400	Set tiranteria	73	755002400	Linkage set
74	755003100	Portamozz! anteriori	74	755003100	Front stub axle
75	755003200	Portamozz! posteriori	75	755003200	Rear stub axle
76	755003300	Distanziale trascinatore mm. 6x10x2	76	755003300	Spacer - 6x10x2 mm
77	755100000	Campana Z. 16 - 19	77	755100000	Clutch bell - Th. 16 - 19

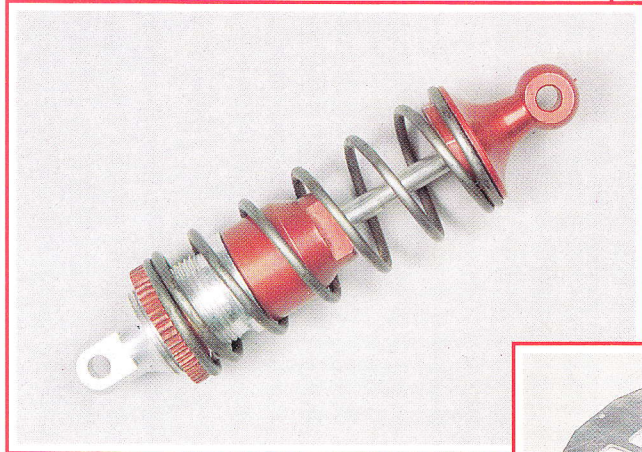

Art. 708230000 Anteriori - Front
Art. 708240000 Posteriori - Rear
 Ammortizzatori a volume costante
 Permanent oil volume shock absorber

Art. 755200000 Anteriori - Front
Art. 755210000 Posteriori - Rear
 Ammortizzatori a doppio effetto con stelo in volframo
 Shock absorber double effect with special steel axle

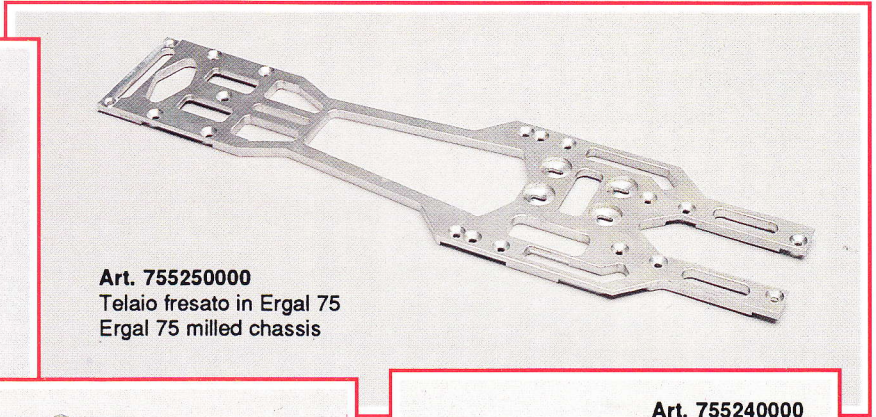

Art. 755250000
 Telaio fresato in Eragal 75
 Eragal 75 milled chassis

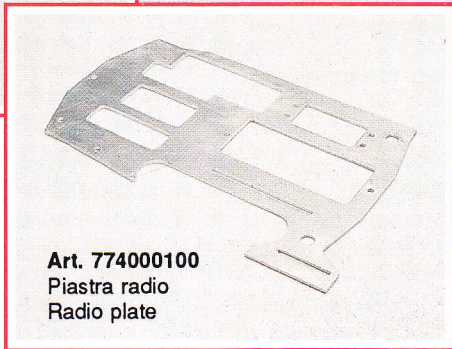

Art. 774000100
 Piastra radio
 Radio plate



Art. 755240000
 Supporto cambio
 Third support

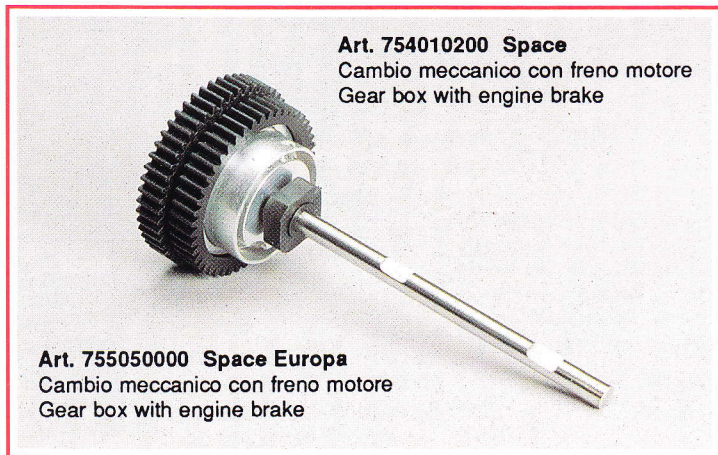

Art. 754010200 Space
 Cambio meccanico con freno motore
 Gear box with engine brake

Art. 755050000 Space Europa
 Cambio meccanico con freno motore
 Gear box with engine brake



Art. 755060000
 Set barre stabilizzatrici posteriori
 Set of rear stabilizers

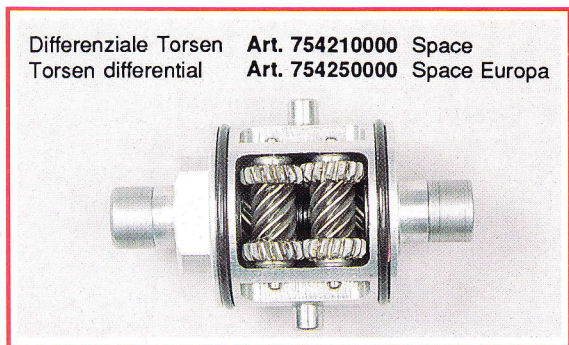

Differenziale Torsen **Art. 754210000** Space
 Torsen differential **Art. 754250000** Space Europa

Il differenziale **TORSEN**, definito dai tecnici "intelligente", permette un maggior scarico di potenza sulle ruote evitando lo slittamento in uscita delle curve o dopo i salti fornendo sempre la stessa coppia ad entrambe le ruote. E' stato realizzato identico all'originale impiegato da Lancia, Lotus, Ferrari con la sola eliminazione di due viti senza fine. Siamo gli unici al mondo che producono un simile differenziale.

The **TORSEN differential**, called "clever unit", guarantees the automatic distribution of the power on each wheel in any circuit condition. This device is a scale copy of the Ferrari - Lancia - Lotus differentials with two pairs of endless screws instead of three for space problems.

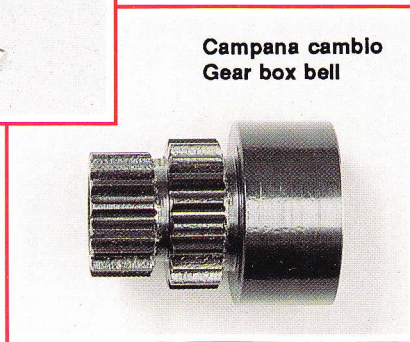

Campana cambio
 Gear box bell

Art. 754230000
 Cuscinetto - Ball-bearing \varnothing mm. 5x13x4

Art. 754240000
 Set cuscinetti per pignone
 Set ball-bearings for pinion

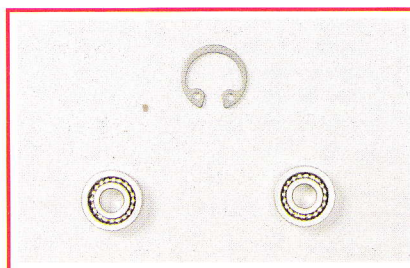

- Art. 755080000** Z 15-18
- Art. 755090000** Z 15-19
- Art. 755100000** Z 16-19
- Art. 755110000** Z 16-20
- Art. 755120000** Z 17-20
- Art. 755130000** Z 17-21

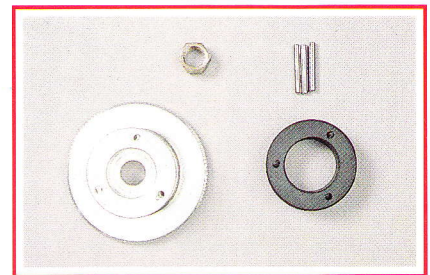

Art. 700021320
 Ceppi in carbonio - Carbon clutch

Art. 700021321
 Molle di ricambio - Springs

Art. 700021322
 Volano con spine - Flywheel

Art. 754220001
 Dado frizione - Nut

Art. 754220000
 Volano con frizione a tre ceppi universale
 Universal three shoe clutch & flywheel



Art. 740040000
Cassetta d'avviamento per modelli da pista senza motore e 2 volt.
Asphalt car starting box without motor & glow driver.

Art. 740020000
Cassetta d'avviamento per modelli da pista completa di cavi, motore e regolatore candela.
Asphalt car starting box with motor & glow driver.

Art. 700020803
Ruota avvitatore in gomma
Rubber starting wheel



Art. 700020799
Motore elettrico
Electric motor

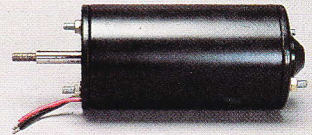

ACCESSORI ACCESSORIES

Art. 764070000
Pacco batterie Rx
Rx power-pack

Art. 700051171
Caricabatterie 3 uscite
3 way Charger

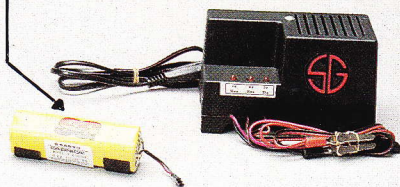

Art. 764010000
Cella NiCd 1,2 volt
Niid 1,2 volt Battery
conf. - pck. = 4 p.

Art. 764080000
Pacco batterie Tx
Tx power-pack



Art. 708970000
Chiave a 4 vie
4-w. Wrench



Art. 703000000 N° 4
Art. 703010000 N° 5
Candele - Glow-plugs



Art. 700002374
Pinza per candela
Glow plug clip

Art. 700020950
Microtornio elettrico da casa e da campo per le gomme degli automodelli. L'elettrotensile permette la rapida sagomatura e rettificatura di ogni gomma in spugna. 12 volt.
Hand tool for the finishing of all tyres, at home or on the driving circuit.

Art. 700020951 Adattatore Manta - Indy - Adapter
Art. 700020952 Adattatore Mangusta - Space E. - Joker - Adapter
Art. 700020953 Adattatore SG - PB - BP - Ass. - Blitz - Adapter
Art. 700020955 Adattatore Serpent - Adapter

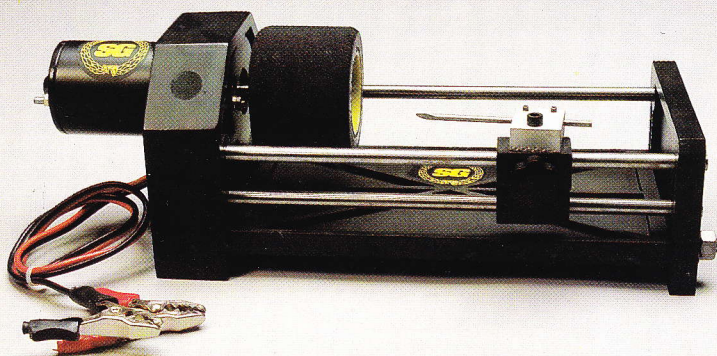

Carrozzeria - Body
Art. 700020363 Mac Laren



Carrozzeria - Body
Art. 700020370 Camaro



Carrozzeria - Body
Art. 707550000 Lola VDS

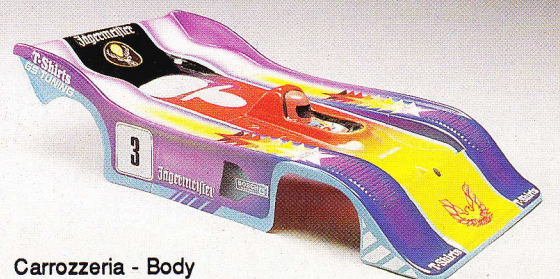

Art. 703080000 BUGGY SE STD.
 Art. 703090000 RE STD.
 Art. 703100000 BUGGY SE PRO.
 Art. 703110000 RE PRO.

Carburatore
 Carburettor
 Art. 703120000 7 mm
 Art. 703130000 9 mm

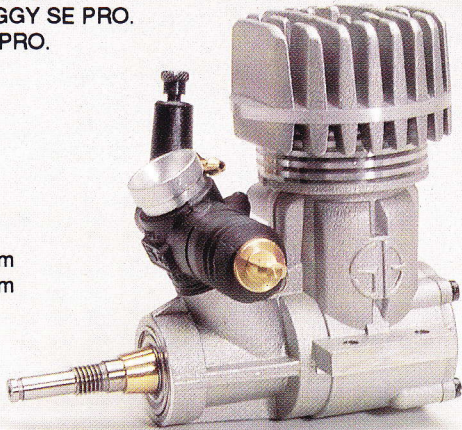

Art. 708920000
 Pipa espansione SG
 SG pipe

Art. 700060219
 Molla - Spring

Art. 708450000
 Silicone per scarico
 Silicone manifold



Art. 754250300
 Raccordo
 Manifold

Art. 702510000
 Fascette in nylon
 Nylon strips



Articolo	703080000	703090000	703100000	703110000
Cilindrata				
Displacement	3,44 ccm	3,44 ccm	3,44 ccm	3,44 ccm
Alesaggio				
Bore	16,55 mm	16,55 mm	16,55 mm	16,55 mm
Corsa				
Stroke	16,00 mm	16,00 mm	16,00 mm	16,00 mm
Potenza				
Power	1,35 HP	1,45 HP	1,55 HP	1,65 HP
Giri al minuto				
R.P.M.	28.500	29.000	30.000	31.000
Travasi				
Transfert port	4	4	4	4
Peso				
Weight gr.	290	290	290	290

Art. 709980000
 Riempitore rapido - Quick filler



Art. 702780000
 Anelli elastici
 Rubber rings

Art. 702630000
 Tubo miscela
 Fuel tubing



Art. 702220000
 Filtro miscela
 Fuel filter



Art. 708320000
 Filtro aria
 Air filter



Art. 755260000
 Pemi posteriori in ergal
 Rear light ergal pins

Art. 755270000
 Barilotti con sfere cromate in ergal
 Spindles with light cromed ergal balls

Art. 755280000
 Corpo differenziale alleggerito
 Light differential side

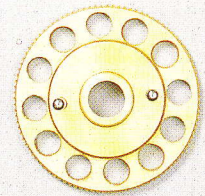

Volano universale alleggerito
 Light weight fly-wheel
 Art. 751320000 ø mm. 39

MISCELA CAR
 CAR FUEL
 10% nitro



Nitrometano - Nitromethane
 Art. 700001076 1 litro - liter
 Art. 700001077 5 litri - liters

Art. 700001050 1 litro - liter
 Art. 700001048 5 litri - liters

EXPERT
 Teflon
 Art. 745757000

BUGGY
 Carbon
 Art. 751007000

PRO
 Ergal-carbon
 Art. 751400000

GRUPPI
 FRIZIONI
 CLUTCH SET

